

03.01.94

istniejące  
podziemia  
kanalizacyjne  
w pom.  
zabudowy

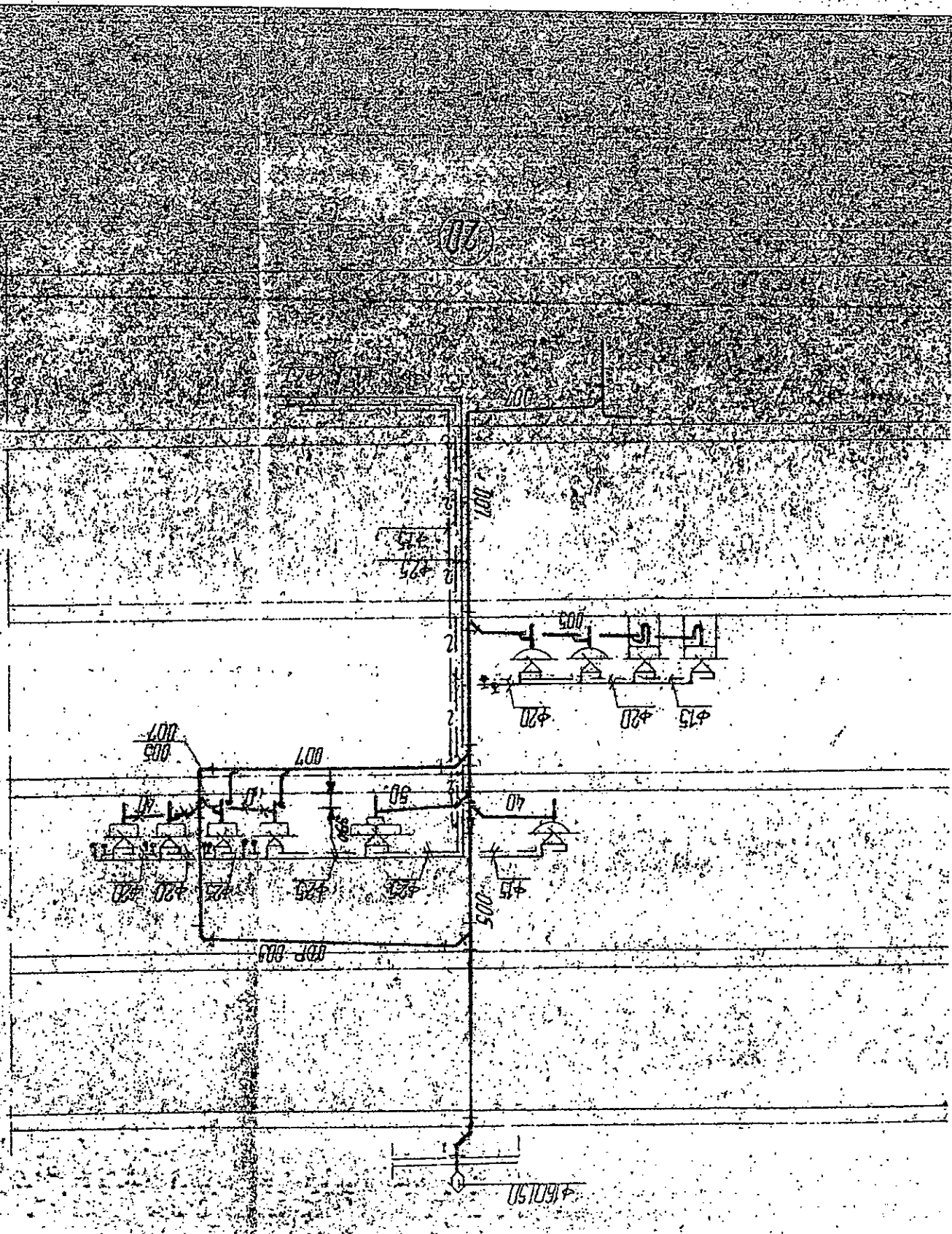

4.10.15

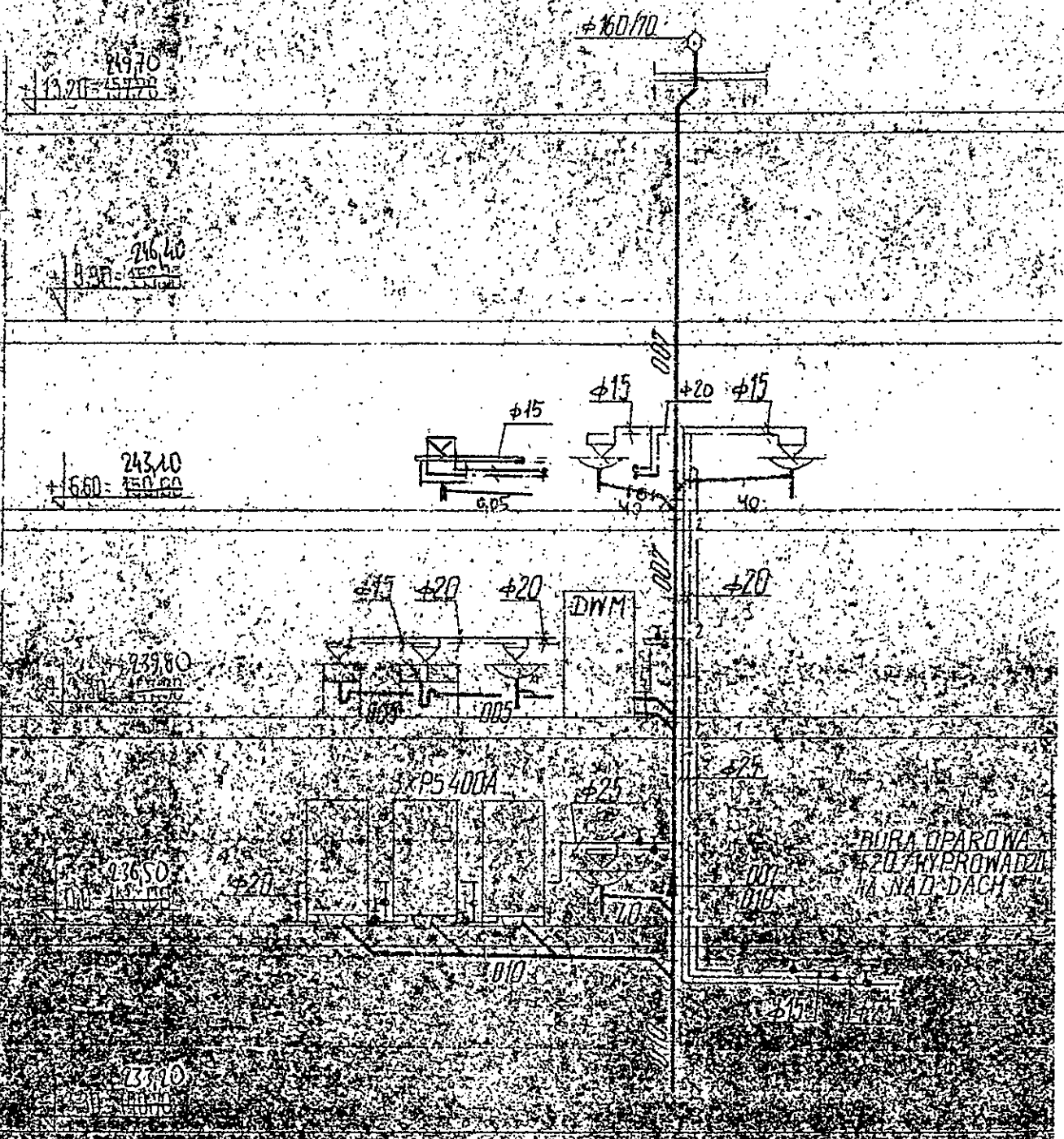

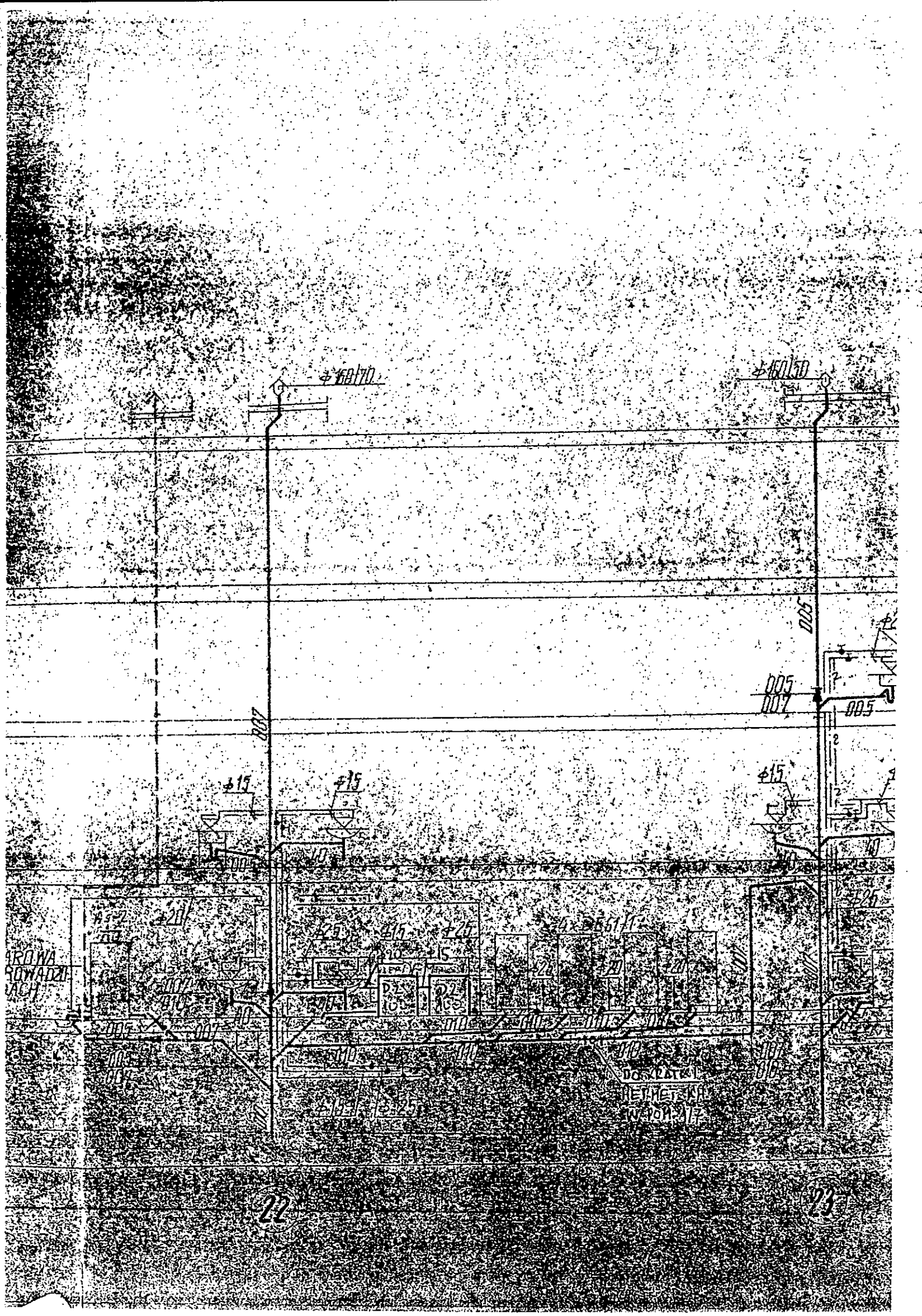

00770

00150

0025

005  
007

007

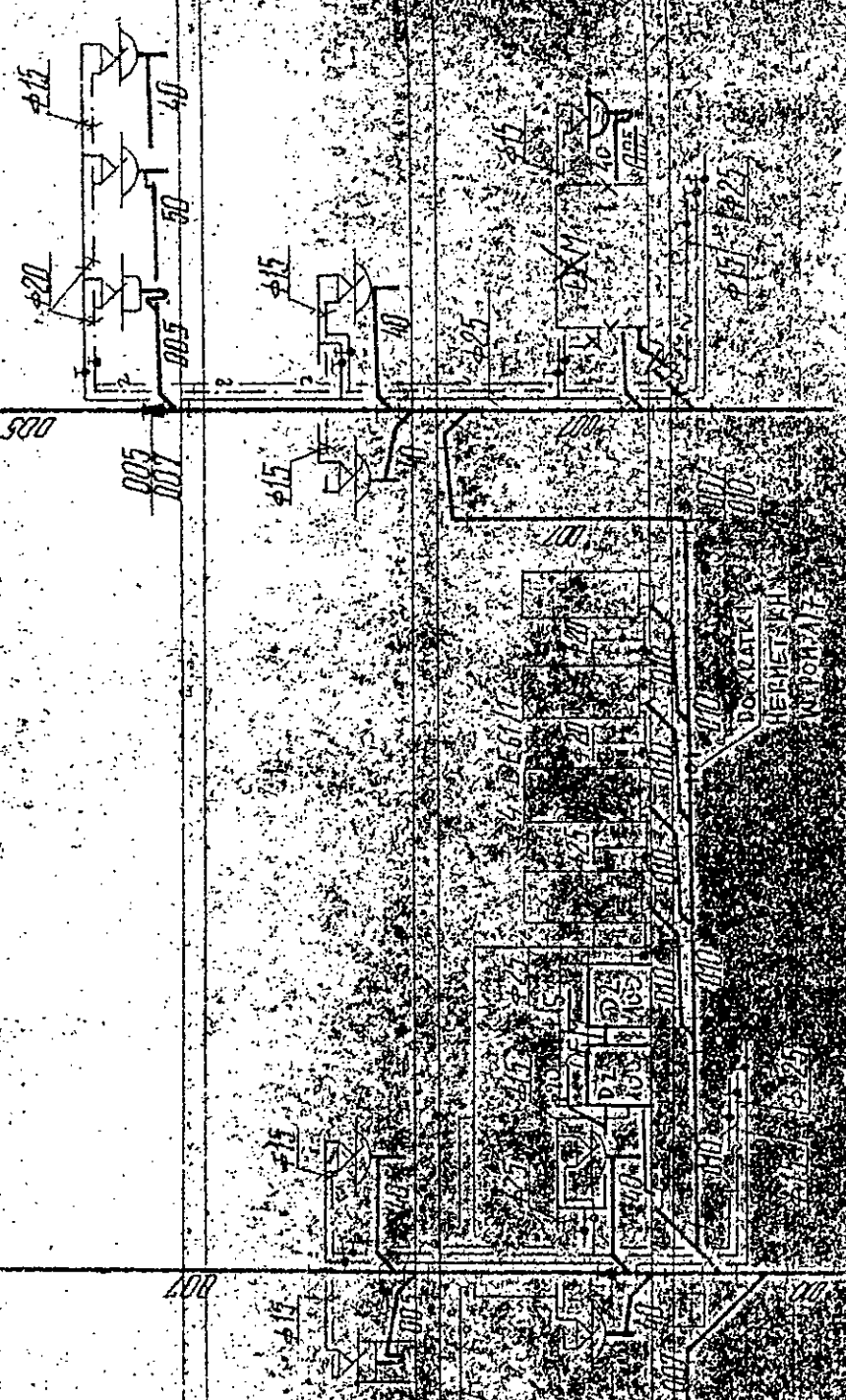

77

77

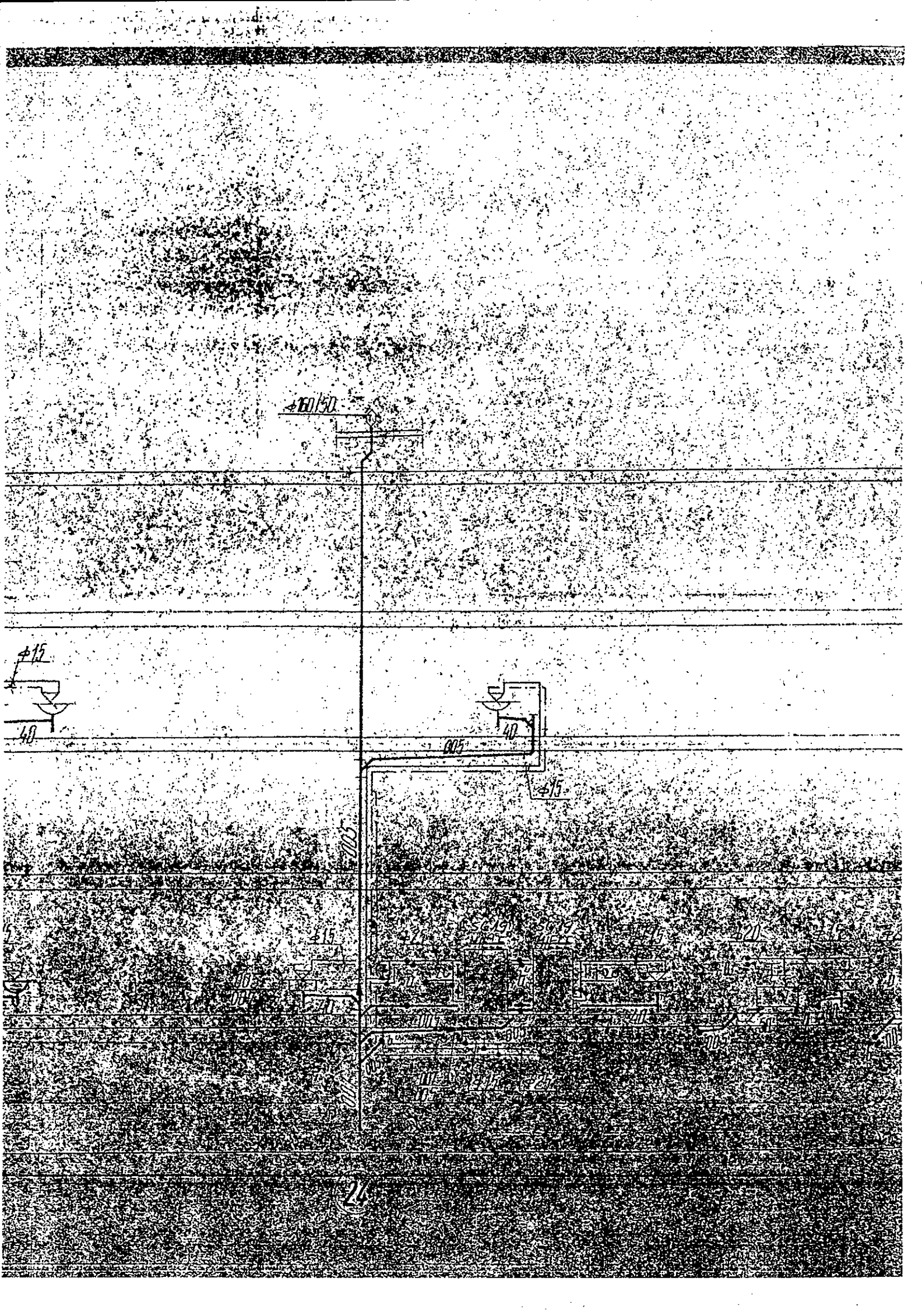

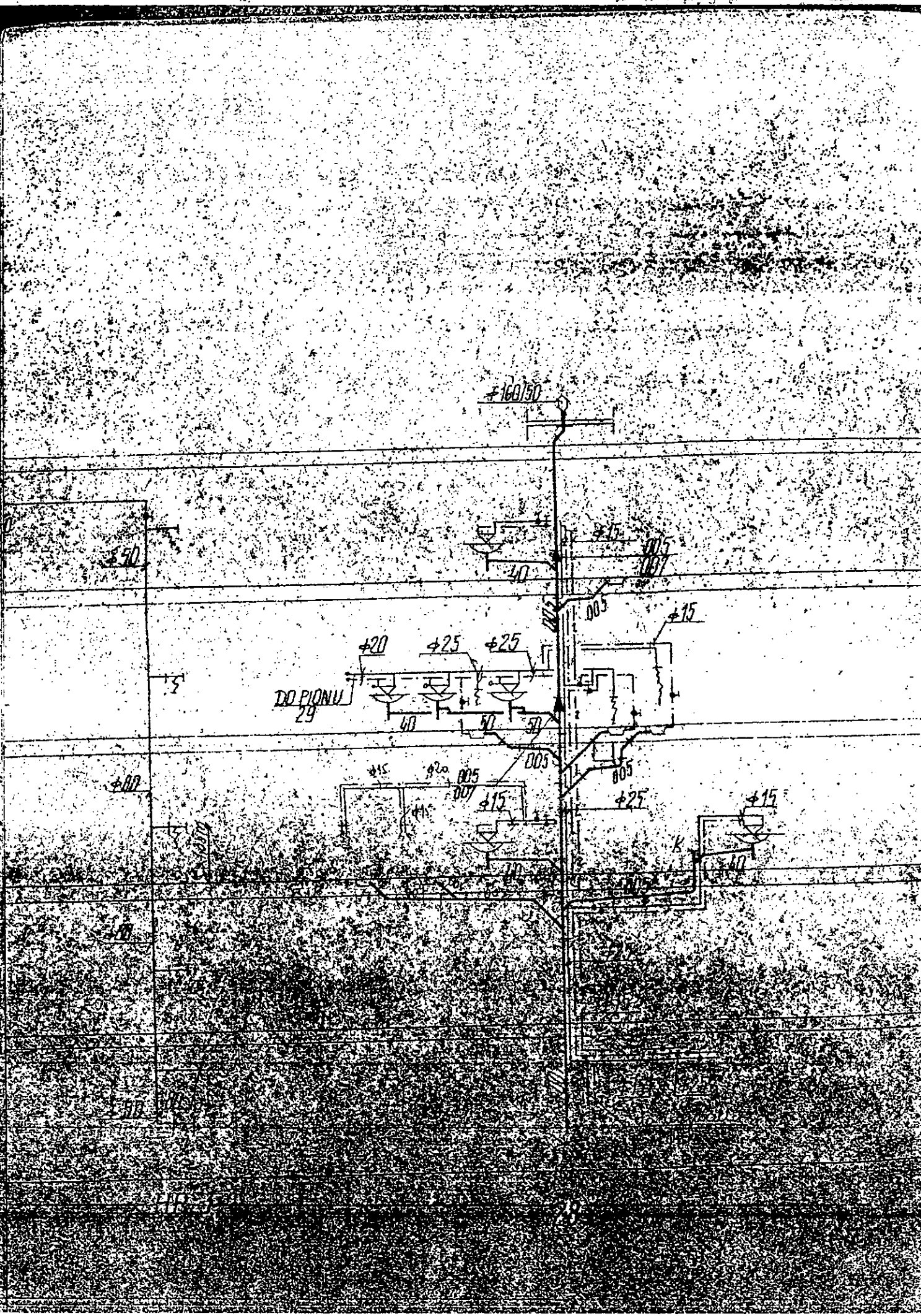

±150.150

±160.170

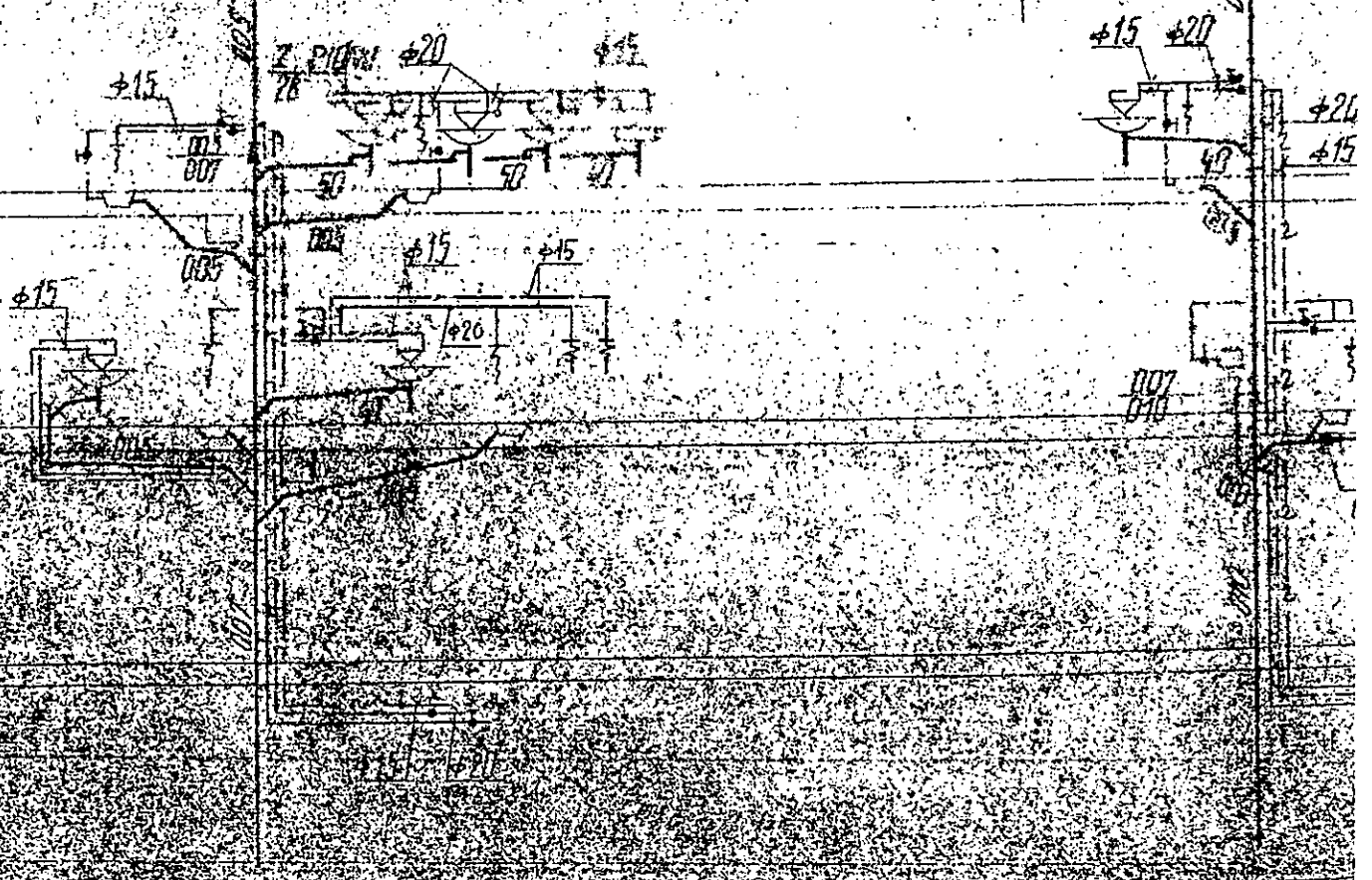

29

30

φ15 φ20

+9.90

φ15 φ20

φ20  
φ15

φ20 φ15

007  
010

005  
007

φ15 φ20

30

ND  
502BY2D

Architect

249,70  
1320 = 15,800

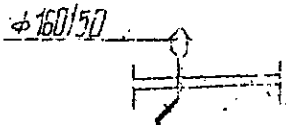

246,40  
9,90 = 15,800

243,10  
16,00 = 15,800

239,80  
13,30 = 15,800

236,50  
10,00 = 14,800

233,20  
3,30 = 14,800

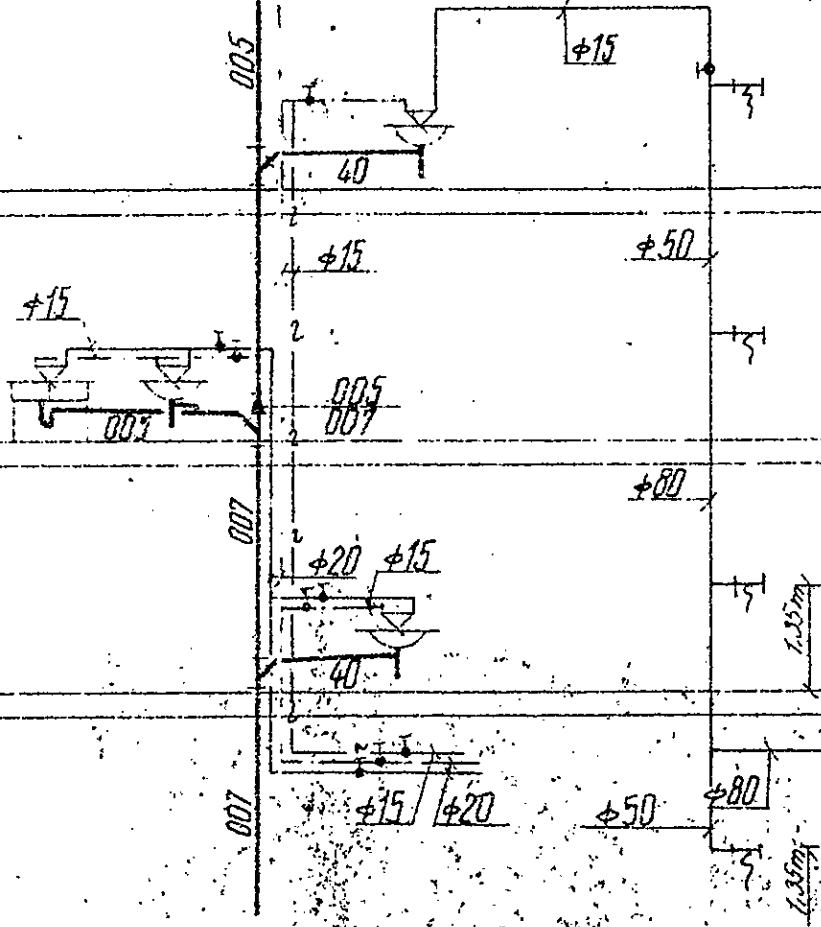

①

HP-1

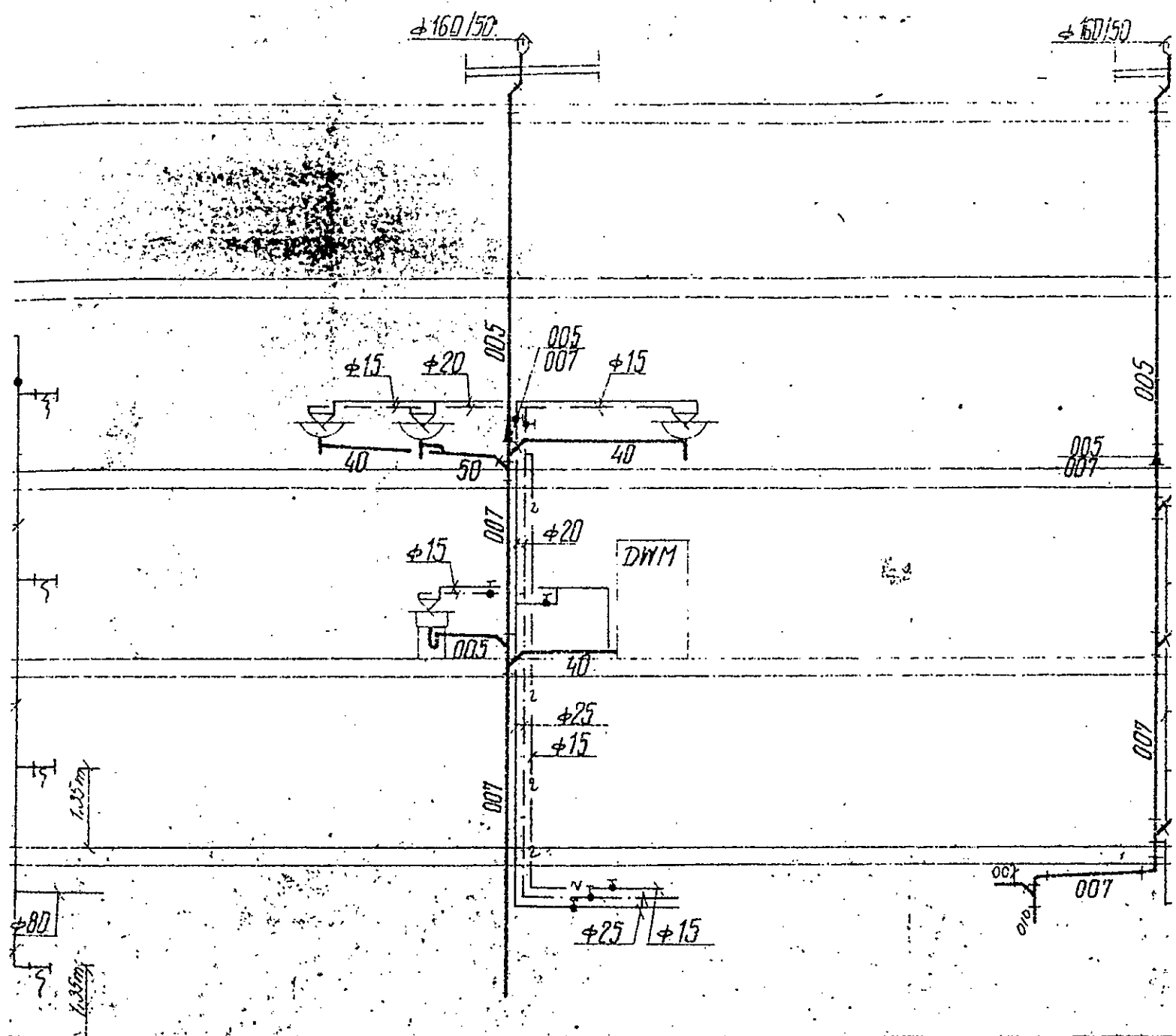

HP-1

②

③

φ 160/70

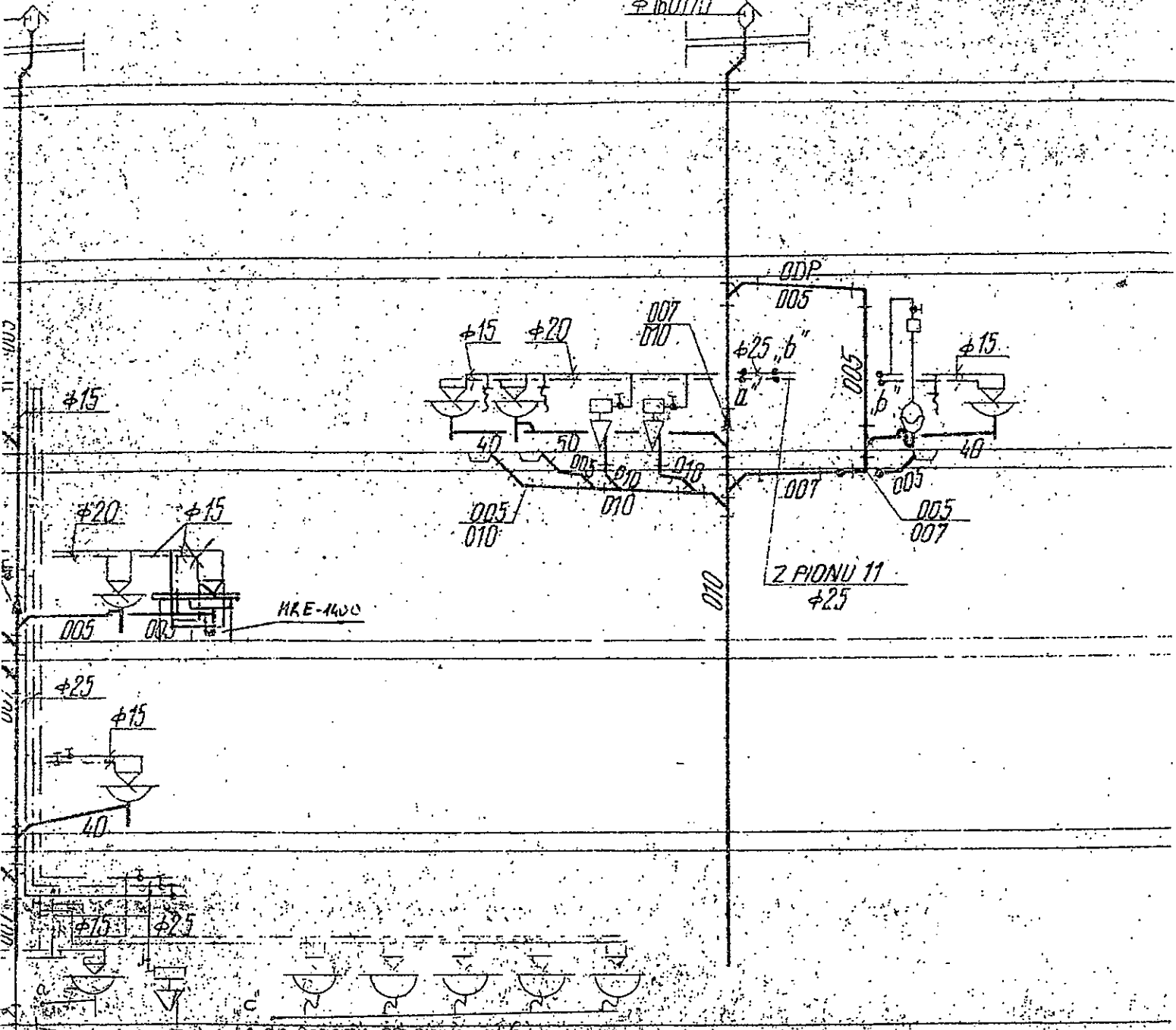

do poziomu 00 pionu 11

7

8

φ160/170

φ160/170

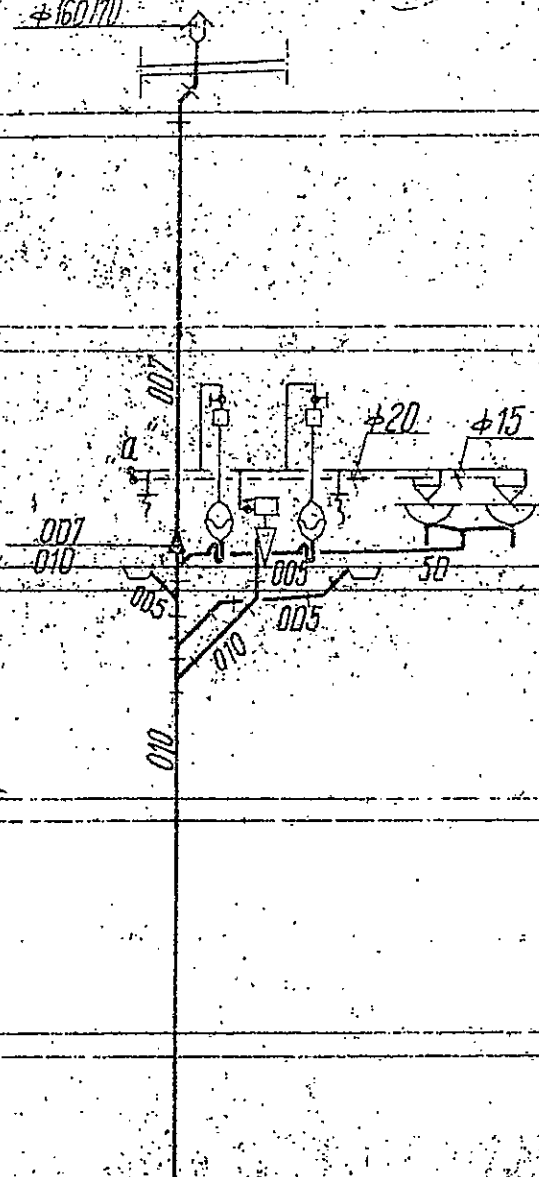

9

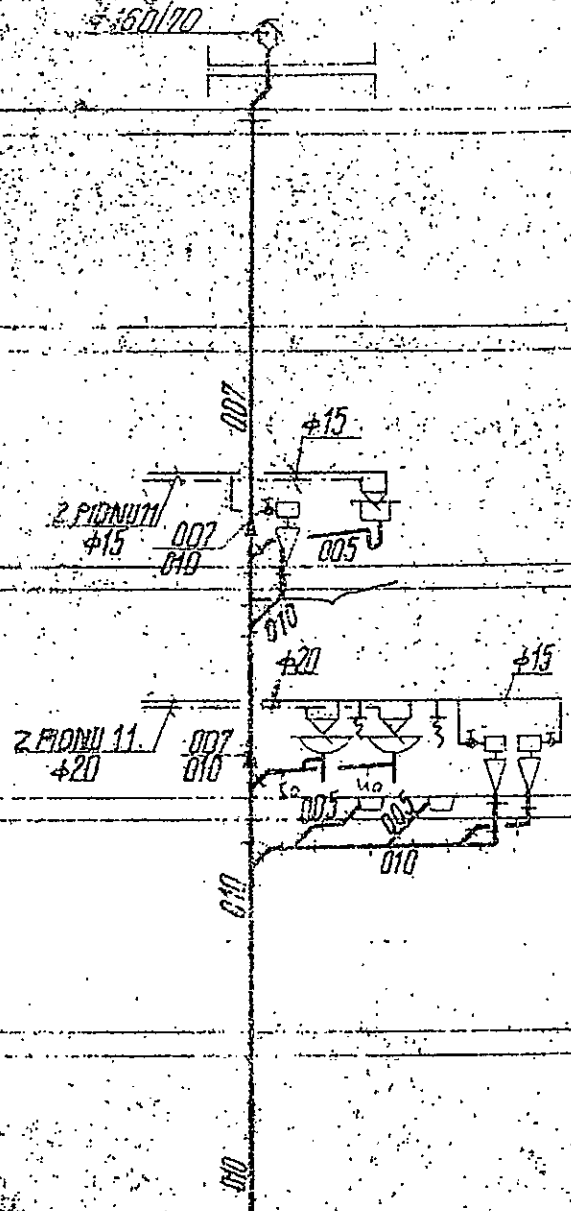

10



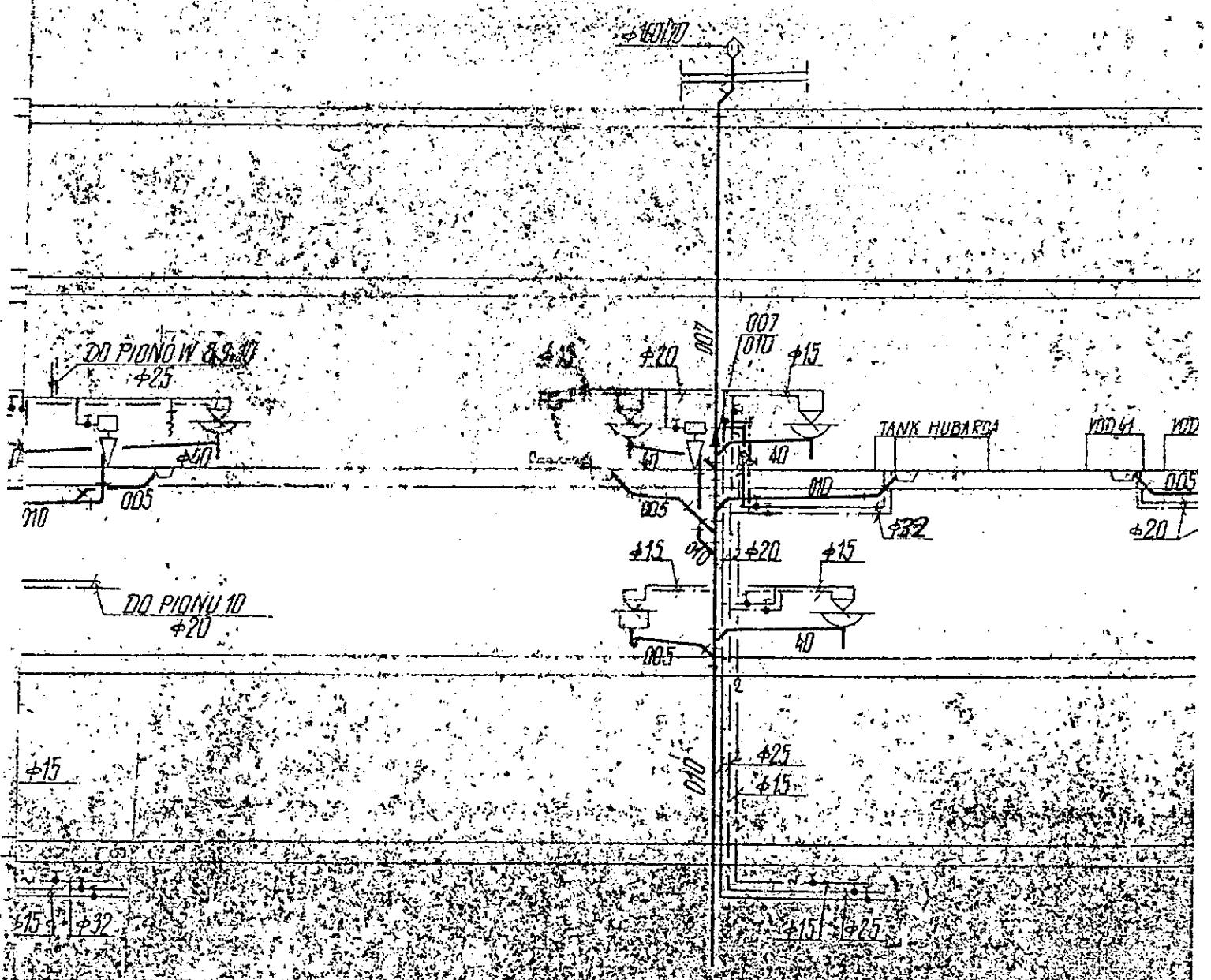

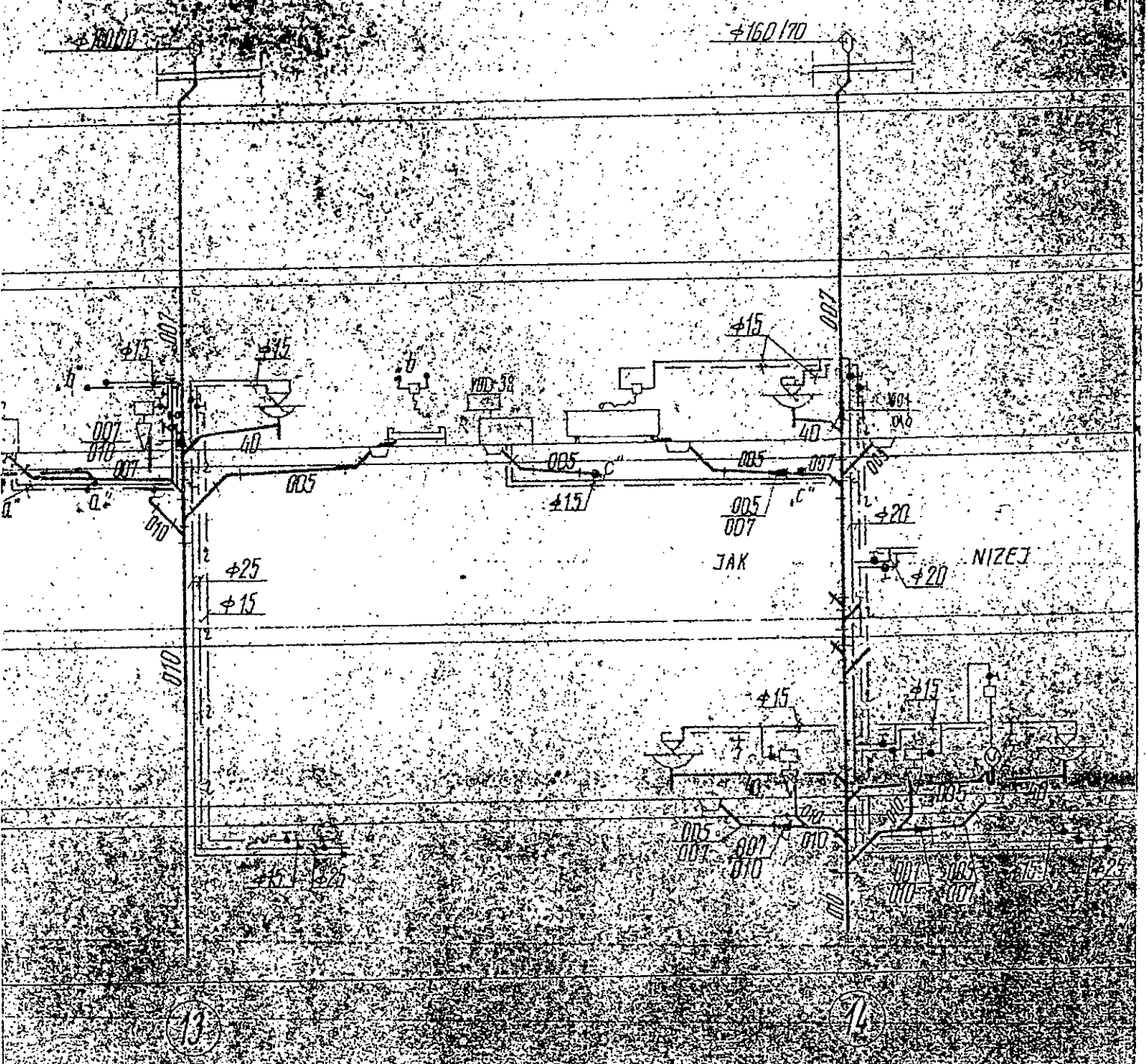

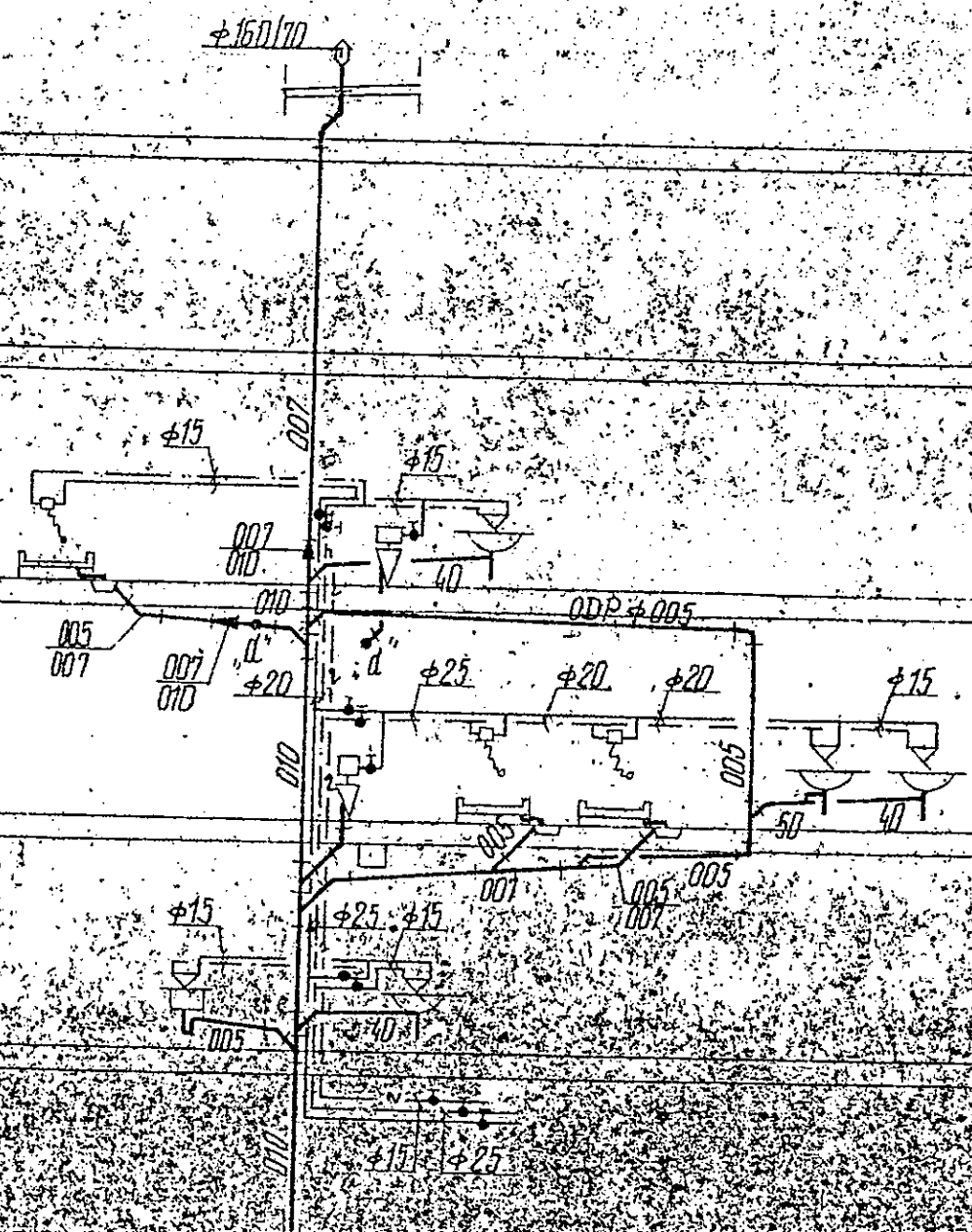

15

# PROFILE KANALIZACJI SANIT

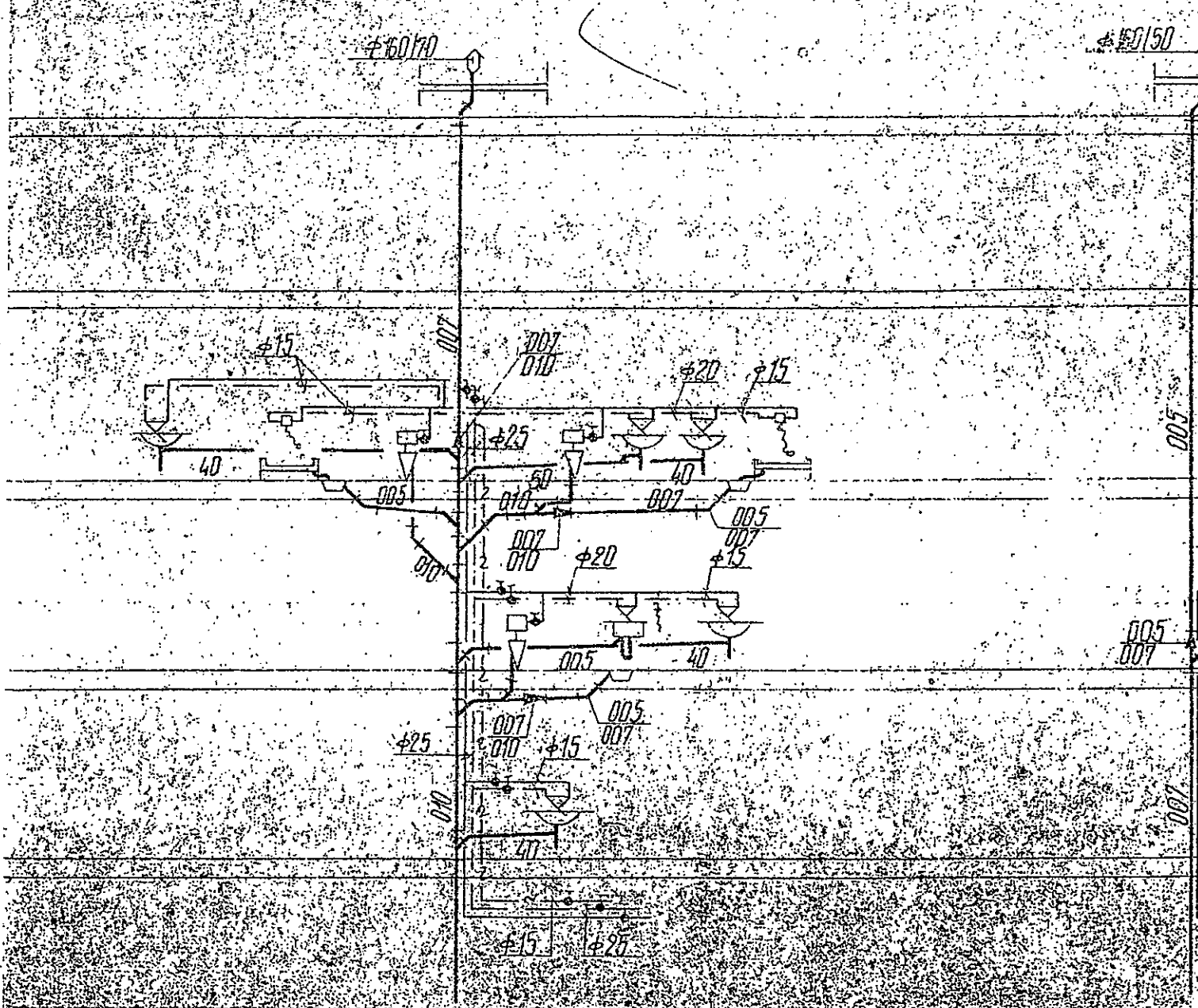

# ARNEJ PIONY 11÷20

